**INSTALLATION • OPERATION
OWNER'S MANUAL**



Induction Holding Well

Models IDW650S, IDW650L

CookTek Induction Systems, LLC

Phone: 1-800-908-8726
+1 214-379-6000

Fax: +1 214-379-6073

www.cooktek.com

customerservice@turbochef.com

PREPARING YOUR COOKTEK INDUCTION HOLDING WELL UNIT FOR USE

Before operating your induction dry well, do the following:

- Remove all packing material and save for subsequent shipment or in case of concealed shipping damage.
- Keep unit away from other heat sources and allow at least 2" (51 mm) between all sides of the housing and any surface or obstacle, and 6" (152 mm) between the bottom of the housing and any surface or obstacle. If either the air intake or exhaust outlet is blocked, the internal temperature will rise, causing an error code to occur.

Grounding Instructions:

The dry well must be properly grounded. In the event of an electrical short circuit, grounding reduces the risk of electric shock by providing a safe path for the electric current. The dry well has a power cord with a 3-prong grounding plug, which must be used in a compatible and properly grounded outlet. It is the owner's responsibility to replace any 2-prong wall outlet with a properly grounded 3-prong wall receptacle.

For your safety, never cut, remove, or disable the electrical (ground) connection from the plug. Never use an adapter plug or an extension cord with the dry well.

WARNING: Electric shock can result from an improperly grounded plug. Please consult a qualified electrician if you have any questions about these grounding instructions.

Before you begin:

Please make sure that this power cord is firmly attached to your CookTek unit BEFORE plugging the unit into the power receptacle and before attempting operation.

ELECTRICAL INSTALLATION REQUIREMENTS

Every installation site has different electrical wiring. Because many different local codes exist, it is the Owner and Installer's responsibility to comply with those codes. CookTek is not responsible for any consequential damages as a result of failure to comply with installation requirements.

- Read all installation instructions carefully before starting installation.
- Remove dry well carefully from carton.
- Remove all loose packaging and accessories and save for subsequent shipment or in case of concealed shipping damage.
- It is the responsibility of the installer to comply with all federal, state and local codes.
- Any installation not matching the specifications discussed in this manual automatically voids the product's warranty.

MECHANICAL INSTALLATION

- Insert the unit in the counter cutout and, if desired, caulk around the seam to seal.
- Plug one end of the control cable into the unit and thread the cable through the cutout for the control box.
- Plug the other end of the control cable into the control box and mount the control box with four screws in the desired location.

GENERAL INFORMATION

The 650 watt dry well system is available two different sized chassis. Both models use SmarTemp™ technology to actively control the temperature of the pan. Factory setting allows the user to choose from four temperature settings in Fahrenheit or Celsius. The number of temperature settings can also be increased to fifteen total using the “Changing the Temperature Settings” option on page 5, and the temperature scale changed between Fahrenheit and Celsius using the “Changing the Temperature Scale” option on page 5.

User Interface Buttons

Power Button – Use this button to turn the unit on and off. A green LED will indicate when the unit is on.



Lock Button – Use this button to prevent users from adjusting settings. Pressing this button three times will lock the unit. When the unit is locked, the only button that will continue to work is the Power button. To unlock the unit, press the Lock button three times. The red LED to the right of the button will indicate when the unit is locked. Pressing the lock button once will also display the current timer value (when the timer feature is enabled).



Up and Down Arrows – These buttons allow you to quickly set the temperature.



Alphanumeric Display – Displays holding temperature (Fahrenheit or Celsius) and error code information.



Control Panel

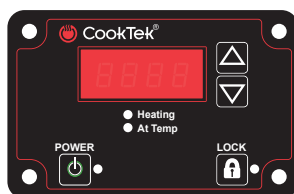

APPROVED FOR COMMERCIAL USE

CookTek's dry well is in conformance with ANSI/UL 197 and CSA 22.2 No. 109 standards and bears the commercially rated approvals. CookTek's dry well is in conformance with European Economic Area standards and bears the CE marking signifying European Conformity.

GENERAL OPERATION



Plug the dry well into a grounded, single-phase receptacle. All models will run on 100-130VAC drawing up to 650W. Check the rating plate on the unit to verify correct voltage and wattage. Voltages below 120VAC can result in less than rated power and slower heating times. This appliance is designed for holding food products only.

Note: For proper operation, an independent, dedicated circuit should be used for up to 3 units installed on a 15amp (120VAC) circuit, or 4 units installed on a 20amp (120VAC) circuit.

To operate all models:

- Press the Power button to turn the unit on. The green LED next to the power button will illuminate. Press the Power button when you are finished to turn the unit off. 

- To lock the controls, press the Lock button three times. The red LED to the right of the lock button will illuminate to indicate the unit is locked. Locking the unit will prevent temperature settings from being changed. The Power button will continue to function while the unit is locked. To unlock the controls, press the lock button three more times. Unplugging the unit when powered on will also unlock the unit. 





- Press the Up and Down Arrows to select the desired temperature. The default preset choices are:  

- Fahrenheit Settings: 170, 180, 190, 200
- Celsius Settings: 70, 75, 80, 85



Additional temperature settings are available by changing the temperature settings option. See “Changing the Temperature Settings” on page 5.

Note: When the unit is not in use for 5 minutes, it will enter a power save mode where the Power LED will flash. Press any button on the controls to exit the power save and return to the previous settings.







SMARTEMP™ OPERATION

- Place an induction compatible pan on the unit.
- The letter “F” or “C” will flash in the display window and the Heating LED will turn on. 
- When the pan has reached the selected temperature, the “F” or “C” will stop flashing and remain solid. The Heating LED will turn off and the At Temp LED will turn on. 
- The set temperature can be adjusted at any time while the pan is on the unit by pressing the Up and Down Arrows.  
- When a pan is removed from the unit, the Heating and At Temp LEDs will turn off and the “F” or “C” will turn on solid in the display. The unit is not heating or holding the set temperature when both LEDs are off.
- When finished using the unit, press the Power button to turn the unit off. The Power LED will turn off. Remove then pan from the unit. The unit will remember the last temperature setting the next time it is powered on. 

CHANGING THE TEMPERATURE SCALE (F/C)

- Starting with the unit off, hold down the Up Arrow while pressing the Power button.  
- Use the Down Arrow to select the desired scale.
- Press the Power button to save the selection.
- Note: If a button is not pressed for more than five minutes, the unit will power off, keeping the previously set temperature scale.

CHANGING THE TEMPERATURE SETTINGS

- Starting with the unit off, hold down the Up Arrow and Down Arrow while pressing the Power button.   
- Use the arrow keys until the text “SETS” appears in the display. Press the Lock button to select this feature. 
- Use the Down Arrow key to toggle between the two options “PART” and “FULL.” Press the Power button to save the selection.  
 - Selecting “PART” will make available the standard set temperatures listed in the “General Operation” section.
 - Selecting “FULL” will make a greater number of set temperatures available. The set temperatures available with this selection are:
Fahrenheit: 130, 135, 140, 145, 150, 155, 160, 165, 170, 175, 180, 185, 190, 195, 200, 205, 210
Celsius: 20, 25, 30, 35, 40, 45, 50, 55, 60, 65, 70, 75, 80, 85, 90, 95, 100
- Note: If a button is not pressed for more than five minutes, the unit will power off, keeping the previously selected temperature settings.

CARE AND CLEANING

Your CookTek induction dry well is easy to keep clean. Be sure to follow these easy instructions:

- Turn the unit OFF and remove the plug from any power outlets prior to cleaning.
- When the unit cools, wipe off with a damp cloth.
- To clean the surface, use a mild detergent or glass cleaning cream.
- Never immerse the dry well in water or put it in the dishwasher.

To clean the control panels:

- Control panels should only be cleaned with a damp cloth.
- Exposure to water spray may cause control panel failures.
- Control panels should only be mounted vertically never horizontally.
- Control panels are NOT water tight.

TIMER OPERATION

- To enable/disable the timer feature, see “Setting the Timer” below.
- If the timer is enabled, the timer will start counting when a pan is placed on the unit and the Heating or At Temp LED will turn on.
- The timer will count continuously up (in minutes) until it is reset by removing the pan.
- The timer is reset when the pan is removed from the unit and the Heating or At Temp LED turns off. The next time a pan is placed on the unit the timer will start again from the beginning.
- To view the elapsed time from when the pan was placed on the unit, press the Lock button once. This will display the time (in minutes) from when the pan was placed on the unit for 5 seconds. After 5 seconds the normal temperature display will return.

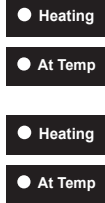

SETTING THE TIMER

The dry well units are equipped with a timer that can be set to alert the operator how long a pan has been on the unit for a period of time up to 240 minutes (4 hours).

To enable/disable the timer:

- With the unit off, hold the Down Arrow while pressing the Power Button.
- Release the buttons when the display comes on. Use the Up and Down Arrows to toggle through the options until “t En” is shown on the display. Press the Lock Button once to select the enable option.
- Press the Up and Down arrows to toggle between the two setting options “on” and “off.” When the desired option is displayed, press the Lock Button once to enter this option. The display will flash three times to indicate the option has been saved.
- Press the Power Button to exit this mode.



IMPORTANT INFORMATION AND SAFETY PRECAUTIONS



WARNING: When operating this appliance, strictly adhere to the following safety precautions to reduce the risk of burns, electric shock, fire, injury, and damage to appliance or property near appliance.

- Read all instructions before using this appliance.
- This appliance must be grounded. Connect only to a properly grounded outlet. See “Grounding Instructions” on page 2. DO NOT use an extension cord.
- Install or locate this appliance only in accordance with the provided installation instructions on page 2 of this manual.
- Keep appliance away from person(s) with reduced physical, sensory, or mental capabilities unless supervised/instructed on how to properly use the appliance.
- Keep children 8 years and younger away from the appliance when in operation. Children 8 years and above may use the appliance with proper adult supervision.
- DO NOT allow children to clean or perform maintenance on this appliance without adult supervision. DO NOT allow children to play with this appliance.
- Always unplug the appliance immediately after use and allow for cooling time if handling, transporting, or storing.
- To disconnect the appliance, press the POWER button and wait for the LED to no longer be illuminated. You may then remove the plug from the outlet.
- DO NOT use the dry well’s surface for storage purposes.

- Never heat empty cookware. Doing so may damage the unit or cookware and overheat the unit. When overheating occurs, an error code will flash on the display and the unit will shut itself off automatically. When the temperature returns to normal, the unit can be used again.
- The cookware in the appliance will heat continuously as long as the power is ON. The cookware will be hot and caution should be exercised when working on or near the appliance.
- This product may only be serviced by an authorized service agent or by CookTek personnel. DO NOT attempt to open the unit or perform service of any kind. For service information, contact CookTek at +1 (214) 379-6000.
- DO NOT use the dry well for anything other than its intended use as described in this manual. This unit is designed to heat food and is not intended for laboratory or industrial use.
- The CookTek dry well comes with a stand-alone (not built-in) control box for unit operation. Use ONLY the control box that comes with the unit to avoid any possible operation hazards.
- DO NOT use any appliance that has a damaged cord or plug, or one that has malfunctioned or been damaged. Consult the warranty at www.cooktek.com/warranty-service and follow instructions for service.
- The IDW dry wells are designed to use CookTek induction-compatible 11" (279 mm) or 14" (355 mm) round pans only (sold separately. Pan size dependent on model.)
- DO NOT use any accessories or attachments that are not recommended by the manufacturer. Use of unapproved accessories may cause injuries and void the warranty.
- DO NOT let the power cord touch hot surfaces or hang over the edge of the counter.
- DO NOT move the appliance when electric power is connected.
- Never immerse cords, plugs, or the appliance in water.
- DO NOT put food or unopened cans on the dry well's surface.
- DO NOT leave the appliance unattended while in use.
- In the unlikely event of a grease fire, smother flame by covering cookware with a tight-fitting lid, cookie sheet, or flat tray. DO NOT USE WATER. When the fire is under control, turn off the appliance and unplug from wall.
- Users wearing a pacemaker should consult their doctor or the pacemaker manufacturer prior to operating CookTek induction equipment. The electro-magnetic field may interfere with the proper function of the pacemaker.
- Turn off the dry well off after each use.
- Keep the soup well away from metallic surfaces, gas and electric ranges, and open flames. DO NOT place in the oven. If the ambient air temperature is above 110°F (43°C), the unit may not function properly.
- Metallic objects such as kitchen utensils, knives, spoons, etc. should not be placed on appliance. Use caution when wearing rings, watches, and other metallic objects as they may get hot if placed near the unit's surface.
- DO NOT place aluminum foil or plastic objects on the dry well's surface.
- DO NOT use the dry well near a faucet, swimming pool, sink, or other areas where water can be found. Never store the unit upside down or in a non-climate controlled environment.
- DO NOT strike or damage the dry well. DO NOT put the unit in your luggage. Throwing or dropping the unit can damage the internal components or crack it, voiding your warranty. If the dry well becomes cracked, unplug the unit immediately and do not use it.
- DO NOT obstruct, block, or alter openings or holes in the dry well housing. DO NOT stick foreign objects into these openings.
- DO NOT use a water jet to clean the appliance.
- If the power cord is damaged, it must be replaced by the manufacturer, its service agent, or a similarly qualified person.

WARRANTY STATEMENT

Please visit www.cooktek.com/warranty-service for CookTek Warranty information.

TROUBLESHOOTING

Symptom	Error Cause	Displayed Message
No power (no lights or fan noise.)	<ul style="list-style-type: none"> • Unit unplugged. • No power to receptacle. 	<ul style="list-style-type: none"> • Plug unit into appropriate receptacle • Make sure that receptacle is energized. • Check wall switches. • Check circuit breaker. • Plug a different electronic device into the receptacle to make sure that power is present.
Pan does not heat.	<ul style="list-style-type: none"> • Pan is not induction efficient. • Pan not centered. 	<ul style="list-style-type: none"> • Use induction efficient pan. • Center pan.
Dry well suddenly stops heating.	<ul style="list-style-type: none"> • Possible power brown out. • Circuit shared with another electrical device. • Safety shut-off engaged. 	<ul style="list-style-type: none"> • Assure proper voltage/power levels. • Make sure the dry well is not sharing a circuit with electrical devices other than CookTek dry well units. • The safety shut-off will engage if an empty pan is left on the dry well surface while the unit is working at full power. Make sure that the dry well surface is clear. Wait 15-20 minutes for the unit to reset.
Pan does not get hot enough even though power levels are set to maximum – induction efficient pan in use.	<ul style="list-style-type: none"> • Extension cord in use. • Circuit shared with another electrical device. 	<ul style="list-style-type: none"> • DO NOT use extension cords. Extension cords may affect the power levels reaching the appliance. • Make sure that the dry well is not sharing a circuit with other electrical devices.
Pan heats unevenly, does not maintain heat level, or overheats.	<ul style="list-style-type: none"> • Pan is not induction efficient. • Pan bottom may not be flat enough. • Pan not centered. • Pan diameter is less than 7" (178 mm). 	<ul style="list-style-type: none"> • Use induction efficient pan. • Use flatter pan. • Center pan. • Use a larger induction efficient pan.

ERROR CODES

In the event of a possible malfunction, your CookTek dry well will display an error code on the alphanumeric display. Some models will beep a specific number of times, indicated by the error and flash the lights on the control box. Please consult the following table when encountering an error code. To reset error conditions, remove the pan from the unit and press the Power button, or unplug the unit.

Error	Error Cause	Displayed Message	Troubleshooting
1	Broken temperature sensor.	E-01	Service required.
2	Broken temperature sensor. Pan temperature is too high.	E-02	Remove any pans from the dry well surface and let cool. Turn unit off and on to reset error. If problem persists, contact service provider.
3	Over current (peak).	E-03	Try different cookware. Service may be required.
6	High line voltage.	E-06	To reset, unplug unit, wait 5 seconds, and plug in again. If problem persists, have an electrician monitor the line voltage.
7	Hardware failure.	E-07	Service required.
8	Zero cross error.	E-08	Turn unit off, then on. Plug unit into outlet on different circuit breaker. If problem persists, service is required on device.
13	User interface error.	E-13	Check control panel connection, cycle power. Service required.
16	Critical error.	E-16	Call dealer for service. Service required.

CLEARANCE AND DIMENSIONS

Clearance: Be sure to allow for a minimum clearance of 2" (51 mm) between all sides of the housing and any surface or obstacle, and 6" (152 mm) between the bottom of the housing and any surface or obstacle. The dry well requires 6-inch² (3870 mm²) of free air space within 8" (203 mm) of the top of cabinet, and within 24" (610 mm) of each unit. Venting can be slots or holes as desired. If the ambient air temperature is above 110°F (43.3°C), the unit may not function properly.

Dimensions (All Models):

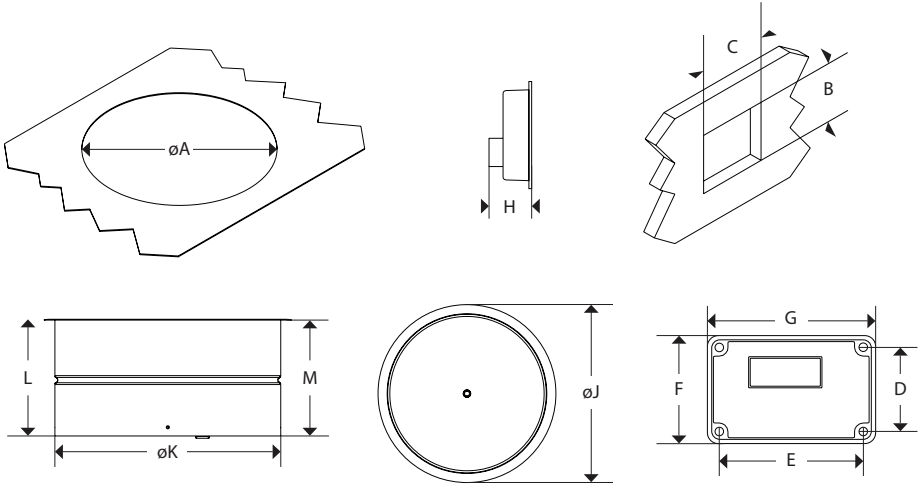

Dimensions				
	IDW650S		IDW650L	
	Inches	mm	Inches	mm
A	11.25	286	14.75	375
B	2.25	57	2.25	57
C	2.9	74	2.9	74
D	1.91	49	1.91	49
E	3.26	83	3.26	83
F	2.46	62	2.46	62
G	3.81	97	3.81	97
H	1.02	26	1.02	26
J	12.52	318	16.02	407
K	11.1	282	14.6	371
L	6.37	162	7.56	192
M	6.23	158	7.42	188

Doe het volgende voordat u uw kooktop gaat gebruiken:

- Verwijder al het verpakkingsmateriaal
- Zet het toestel op een droge, vlakke, harde, stabiele en onbrandbare ondergrond
- Houd het toestel uit de buurt van andere warmtebronnen en zorg dat er aan de voor- en achterkant en de zijkanten minstens 5 cm vrij is voor luchtcirculatie.

Voor uw veiligheid mag u nooit de elektrische (massa) aansluiting uit de stekker snijden, verwijderen of uitschakelen. Gebruik nooit een aangepaste stekker of een verlengsnoer met de kooktop.

WAARSCHUWING: Een verkeerd geaarde stekker kan u een elektrische schok bezorgen. Raadpleeg een erkende elektricien als u vragen heeft over deze aardingsinstructies.

Voordat u begint:

Controleer eerst of dit snoer stevig aan uw CookTek-apparaat is bevestigd VOORDAT u de stekker van het toestel in het stopcontact steekt en u probeert het te gebruiken.

- Raak de keramische plaat (of de bovenkant van de kooktop) nooit onmiddellijk na gebruik aan. De hitte van de pan wordt op de keramische plaat overgebracht zodat deze heet is bij aanraking.
- Dit product mag uitsluitend worden gerepareerd door een geautoriseerd servicebedrijf of door personeel van CookTek. Probeer niet om het toestel open te maken of op enige wijze te repareren. Neem voor informatie over onderhoud en reparatie contact op met CookTek op 001-214-379-6000.
- Dit toestel moet worden geaard. Alleen aansluiten op een goed geaard stopcontact. Lees voor het gebruik de aardingsinstructies en de vereisten voor de elektrische aansluiting op pagina 2 van dit boekje. Gebruik geen verlengsnoer.

Ennen keittotason käyttöä toimi seuraavasti:

- Poista kaikki pakkausmateriaalit.
- Laita laite kuivalle, tasaiselle, kovalle, tukevalle ja palamattomalle pinnalle.
- Pidä laite erossa muista lämmönlähteistä ja jätä laitteen sivuille, eteen ja taakse vähintään 10 cm (2 tuumaa) vapaa tilaa ilmalle kiertää.

Turvallisuussyistä älä koskaan leikkaa, irrota tai pura sähköliitoksia (maadoitusjohtoa) pistokkeesta. Älä koskaan käytä keittotason kanssa sovitinpistoketta tai jatkojohtoa.

VAROITUS: Väärin maadoitettu pistoke voi aiheuttaa sähköiskun. Neuvottele valtuutetun sähköasentajan kanssa, jos sinulla on kysyttävää näistä maadoitusohjeista.

Ennen kuin aloitat:

Varmista, että tämä virtajohto on tiukasti kiinnitetty CookTek:iin ENNEN laitteen pistokkeen työntämistä pistorasiaan ja ennen käyttökokeilua.

- Älä koske keraamista levyä (keittotason päällä) heti käytön jälkeen. Astian kuumuus siirtyy keraamiseen levyyn kuumentaen sen liian kuumaksi koskettaa.
- Tätä tuotetta saa huoltaa ainoastaan valtuutettu huoltopiste tai CookTekin henkilökunta. Älä yritä avata laitetta ja suorittaa sille minkäänlaisia huoltotoimia. Tietoja huollosta saat soittamalla CookTekiin numeroon +1 214-379-6000.
- Tämä laite täytyy suojamaadoittaa. Liitä ainoastaan oikein suojamaadoitettuun pistorasiaan. Ennen käyttöä lue maadoitusohjeet ja sähköasennusvaatimukset tämän lehtisen sivulta 2. Älä käytä jatkojohtoa.

FRENCH

Avant d'utiliser l'appareil Cooktop, effectuer les opérations suivantes :

- Retirer tous les matériaux d'emballage.
- Placer l'appareil sur une surface sèche, plane, solide, stable et non inflammable.
- Placer l'appareil à distance de toute autre source de chaleur et laisser un espace libre d'au moins 5 cm (2 pouces) des deux côtés, à l'avant et à l'arrière de celui-ci pour permettre la circulation de l'air.

Pour votre sécurité, ne jamais couper, déconnecter ou désactiver le raccordement électrique (terre) de la prise de courant. Ne jamais utiliser un adaptateur ou une rallonge électrique avec l'appareil Cooktop.

MISE EN GARDE : Une prise de courant incorrectement raccordée à la terre engendre un risque de choc électrique. Pour toute question concernant ces instructions de mise à la terre, consulter un électricien qualifié.

Avant de commencer :

S'assurer que le câble d'alimentation est solidement fixé à l'appareil CookTek AVANT de raccorder l'appareil à une prise de courant et d'essayer de le faire fonctionner.

- Ne pas toucher la plaque de céramique (ou la partie supérieure de l'appareil Cooktop) immédiatement après utilisation. La chaleur de la casserole se transmet à la plaque de céramique, aussi celle-ci est chaude au toucher.
- L'entretien de cet appareil ne peut être effectué que par un réparateur agréé ou par un membre du personnel de CookTek. Ne jamais essayer d'ouvrir l'appareil ni de le réparer. Pour des informations concernant l'entretien, contacter CookTek au +1 214-379-6000.
- Cet appareil doit être raccordé à la terre. Le brancher exclusivement à une prise de courant correctement raccordée à la terre. Avant utilisation, lire les instructions de raccordement à la terre, ainsi que les exigences en matière d'installation électrique figurant à la page 2 du présent manuel. Ne pas utiliser de câble de rallonge.

GERMAN

Vor Inbetriebnahme des Cooktop verfahren Sie bitte wie folgt:

- Entfernen Sie das gesamte Verpackungsmaterial.
- Stellen Sie das Gerät auf eine trockene, ebene, harte, stabile und nicht brennbare Fläche.
- Halten Sie das Gerät von anderen Wärmequellen fern und lassen Sie um das Gerät herum (vorne, hinten und seitlich) mindestens 5 cm für die Luftzirkulation frei.

Zu Ihrer eigenen Sicherheit darf das Erdungskabel keinesfalls vom Stecker abgetrennt, entfernt oder in schadhaftem Zustand verwendet werden. Benutzen Sie für Ihren Cooktop niemals einen Steckeradapter oder ein Verlängerungskabel.

WARNHINWEIS: Ein nicht fachgemäß geerdeter Stecker kann zu einem Stromschlag führen. Falls Sie noch Fragen zu diesen Anweisungen in Zusammenhang mit Schutzkontakt und Erdung haben, wenden Sie sich bitte an einen Elektrofachmann.

Bevor Sie beginnen:

Dieses Netzkabel muss fest mit dem CookTek verbunden sein, BEVOR Sie das Gerät an die Steckdose anschließen und es in Betrieb nehmen.

- Berühren Sie die Keramikplatte (oder Oberfläche des Cooktop) nicht unmittelbar nach Gebrauch. Die Hitze der Pfanne überträgt sich auf die Keramikplatte, die dann ebenfalls heiß wird.
- Dieses Produkt darf nur durch bevollmächtigte Wartungstechniker oder das Fachpersonal von CookTek gewartet werden. Versuchen Sie nicht, das Gerät zu öffnen und selbst zu warten. Nähere Informationen zur Wartung erhalten Sie bei CookTek unter der Rufnummer +1 214-379-6000.
- Das Gerät muss geerdet werden. Der Stecker muss in eine ordnungsgemäß geerdete Steckdose gesteckt werden. Vor dem Öffnen lesen Sie bitte die Anweisungen zu Schutzkontakt/Erdung und die Anforderungen an die elektrische Installation auf Seite 2 dieses Handbuchs. Verwenden Sie kein Verlängerungskabel.

GREEK

Πριν θέσετε το Cooktop σας σε λειτουργία, εκτελέστε τα ακόλουθα:

- Αφαιρέστε όλα τα υλικά συσκευασίας.
- Τοποθετήστε τη μονάδα σε μια στεγνή, επίπεδη, σκληρή, σταθερή και μη εύφλεκτη επιφάνεια.
- Διατηρήστε τη μονάδα μακριά από άλλες πηγές θερμότητας και αφήστε κενό τουλάχιστον 2 ίντσες (5 εκατοστά) για την κυκλοφορία του αέρα στα πλαϊνά, το μπροστινό μέρος και το πίσω μέρος της μονάδας.

Για την ασφάλειά σας, ποτέ μην κόψετε, αφαιρέσετε ή απενεργοποιήσετε την ηλεκτρική (γείωση) σύνδεση από το φως. Μη χρησιμοποιήσετε ποτέ προσαρμογέα φως ή καλώδιο προέκτασης (μπαλαντζά) με το Cooktop.

ΠΡΟΕΙΔΟΠΟΙΗΣΗ: Ένα εσφαλμένα γειωμένο φιν μπορεί να έχει ως αποτέλεσμα την ηλεκτροπληξία. Παρακαλείστε να συμβουλευτείτε αρμόδιο ηλεκτρολόγο εάν έχετε τυχόν ερωτήσεις σχετικά με αυτές τις οδηγίες γείωσης.

Πριν ξεκινήσετε:

Βεβαιωθείτε ότι αυτό το ηλεκτρικό καλώδιο είναι σταθερά συνδεδεμένο στη μονάδα CookTek σας ΠΡΙΝ συνδέσετε το φιν της μονάδας σε ηλεκτρική πρίζα και πριν προσπαθήσετε να θέσετε τη μονάδα σε λειτουργία.

- Μην αγγίζετε την κεραμική πλάκα (ή το άνω μέρος του Cooktop) αμέσως μετά τη χρήση. Η θερμότητα από την κοιλότητα θα μεταφερθεί στην κεραμική πλάκα. Ως εκ τούτου, αυτή θα είναι πολύ ζεστή για να την αγγίξετε.
- Οι εργασίες επισκευής του προϊόντος αυτού πρέπει να πραγματοποιούνται μόνο από εξουσιοδοτημένο αντιπρόσωπο επισκευών ή από προσωπικό της CookTek. Μην επιχειρήσετε να ανοίξετε τη μονάδα ή να εκτελέσετε οποιαδήποτε εργασία επισκευής σε αυτήν. Για πληροφορίες σχετικά με τις επισκευές, επικοινωνήστε με την CookTek στον τηλεφωνικό αριθμό +1 214-379-6000.
- Η συσκευή αυτή πρέπει να είναι γειωμένη. Συνδέστε μόνο σε σωστά γειωμένη πρίζα. Πριν τη λειτουργία, διαβάστε τις οδηγίες γείωσης και τις απαιτήσεις ηλεκτρικής εγκατάστασης στη σελίδα 2 του παρόντος φυλλαδίου. Μη χρησιμοποιείτε καλώδιο προέκτασης (μπαλαντζά).

ITALIAN

Prima di mettere in funzione il piano cottura, eseguire le seguenti operazioni:

- Rimuovere tutto il materiale di imballaggio.
- Collocare l'unità su una superficie asciutta, piana, rigida, stabile e non infiammabile.
- Tenere l'unità lontana da altre fonti di calore e lasciare almeno 5 centimetri di spazio per consentire la circolazione dell'aria tutto intorno all'unità.

Per la propria sicurezza, non tagliare, rimuovere o disattivare mai il collegamento elettrico di terra dalla spina. Non utilizzare mai una spina adattatore o un cavo elettrico di prolunga per collegare il piano cottura.

AVVERTENZA: una spina elettrica non correttamente collegata all'impianto di terra può provocare scosse elettriche. Rivolgersi a un elettricista qualificato in caso di domande su queste istruzioni di messa a terra.

Prima di iniziare:

Assicurarsi che questo cavo di alimentazione sia collegato saldamente all'unità CookTek PRIMA di collegare l'unità alla presa elettrica e prima di metterla in funzione.

- Non toccare la piastra di ceramica (o la superficie del piano cottura) subito dopo l'uso. Il calore della pentola si trasferisce alla piastra di ceramica, rendendola estremamente calda.
- Questo prodotto può essere riparato esclusivamente da un tecnico autorizzato o dal centro di assistenza CookTek. Non tentare di aprire l'unità o di eseguire interventi di manutenzione di alcun tipo. Per informazioni sull'assistenza, contattare la CookTek al numero +1 214-379-6000.

- Questo apparecchio deve essere collegato a terra. Collegarlo esclusivamente a una presa elettrica dotata di messa a terra. Prima di mettere in funzione l'unità, leggere le istruzioni di messa a terra e i Requisiti di installazione elettrica a pagina 2 di questo opuscolo. Non utilizzare un cavo elettrico di prolunga.

NORWEGIAN

Før du bruker komfyren, må du gjøre følgende:

- Fjern all emballasje.
- Plasser enheten på et tørt, jevnt, hardt, stabilt og brannsikkert underlag.
- Hold enheten unna andre varmekilder, og la det være minst 5 cm klaring for luftventilasjon på sidene, foran og på baksiden av enheten.

For din egen sikkerhet må du ikke kutte, fjerne eller ødelegge den elektriske (jordede) kopleingen fra kontakten. Ikke bruk en adapterkontakt eller skjøteledning for komfyren.

ADVARSEL: Elektrisk støt kan oppstå fra kontakt som ikke er korrekt jordet. Ta kontakt med en kvalifisert elektriker dersom du har spørsmål om disse jordingsinstruksene.

Før du begynner:

Kontroller at strømkabelen er satt helt inn i CookTek-enheten FØR du kopler enheten til stikkkontakten og før bruk.

- Den keramiske platen (eller overflaten på komfyren) må ikke berøres umiddelbart etter bruk. Varme fra kjeler vil overføres til den keramiske platen og gjøre den varm.
- Dette produktet kan bare repareres av en autorisert serviceagent eller av CookTek-ansatte. Ikke prøv å åpne enheten eller utføre reparasjoner av noe slag. For serviceinformasjon, kontakt CookTek på tf. +1 214-379-6000.
- Dette produktet må jordes. Må kun koples til et korrekt jordet støpsel. Før bruk bør du lese jordingsinstruksene og kravene til elektrisk installasjon på side 2 i denne veiledningen. Ikke bruk skjøteledning.

POLISH

Przed rozpoczęciem używania urządzenia Cooktop, należy wykonać poniższe czynności:

- Usunąć wszystkie elementy opakowania.
- Ustawić urządzenie na suchej, poziomej, twardej, stabilnej i niepalnej powierzchni.
- Ustawić urządzenie z dala od innych źródeł ciepła i zapewnić wokół urządzenia wolną przestrzeń, co najmniej 0,5 cm, aby umożliwić obieg powietrza

Dla bezpieczeństwa użytkownika nie wolno nigdy przecinać, wyjmować ani wyłączać połączenia elektrycznego (uziemienia) z wtyczki. Stosując urządzenie Cooktop nie wolno używać złącza pośredniego ani przedłużacza.

OSTRZEŻENIE: Niewłaściwe uziemienie wtyczki może spowodować porażenie prądem elektrycznym. W przypadku wątpliwości dotyczących instrukcji uziemienia należy skontaktować się z wykwalifikowanym elektrykiem.

Przed rozpoczęciem używania:

Należy sprawdzić, czy przewód zasilania jest pewnie przymocowany do modułu CookTek PRZED podłączeniem urządzenia do gniazdka zasilania i przed rozpoczęciem jego używania.

- Nie dotykać płyty ceramicznej (lub wierzchniej części urządzenia Cooktop bezpośrednio po zakończeniu jego używania. Wysoka temperatura patelni może przenosić się na płytę ceramiczną, stwarzając możliwość oparzenia w przypadku jej dotknięcia.
- Obsługa serwisowa tego produktu może być prowadzona jedynie przez upoważnionego pracownika serwisu lub przez personel firmy CookTek. Nie podejmować samodzielnej próby otwarcia urządzenia ani nie wykonywać żadnych napraw. Aby uzyskać informacje dotyczące obsługi serwisowej, należy skontaktować się z firmą CookTek pod numerem +1 214-379-6000.
- Niniejsze urządzenie wymaga uziemienia. Podłączać jedynie do właściwie uziemionego gniazda. Przed użyciem należy przeczytać instrukcję dotyczącą uziemienia oraz część „Wymogi instalacji elektrycznej” na stronie 2 niniejszej ulotki. Nie używać przedłużacza.

PORTUGUESE

Antes de funcionar com o seu Cooktop, faça o seguinte:

- Retire todo o material de embalagem.
- Coloque a unidade numa superfície seca, nivelada, rígida, estável e não inflamável.
- Mantenha a unidade afastada de outras fontes de calor e deixe um espaço de pelo menos 5 cm nos lados, frente e traseira da unidade, para circulação do ar.

Para sua segurança, nunca corte, retire nem desactive a ligação eléctrica (terra) da ficha. Nunca utilize uma ficha adaptadora nem cabo de extensão com o Cooktop.

ADVERTÊNCIA: Uma ficha incorrectamente ligada à terra pode provocar choque eléctrico. Se tiver alguma questão sobre estas instruções de ligação à terra, por favor consulte um electricista qualificado.

Antes de Começar:

Por favor, certifique-se de que este cabo de energia está ligado firmemente à sua unidade CookTek ANTES de ligar a unidade à tomada de energia e antes de tentar funcionar com ela.

- Não toque na placa de cerâmica (no cimo do Cooktop) imediatamente depois da sua utilização. O calor emitido pelo tabuleiro será transferido para a placa de cerâmica, fazendo com que esta fique quente ao toque.
- A assistência técnica deste produto só pode ser realizada por um agente de assistência técnica autorizado ou por pessoal da CookTek. Não tente abrir a unidade nem efectuar assistência técnica de qualquer tipo. Para informações referentes à assistência técnica, por favor entre em contacto com a CookTek pelo telefone +1 214-379-6000.

- O aparelho deve estar ligado à terra. Ligue apenas a uma tomada correctamente ligada à terra. Antes de funcionar com o aparelho, leia as instruções relativas à ligação à terra e os Requisitos para Instalação Eléctrica na Página 2 deste folheto. Não utilize um cabo de extensão.

SPANISH

Antes de utilizar el anafe (cooktop), realice lo siguiente:

- Retire todo el material de embalaje.
- Coloque la unidad sobre una superficie seca, plana, dura, estable y no inflamable.
- Mantenga la unidad alejada de otras fuentes de calor y deje un margen de al menos 5 cm para que el aire circule por los lados y las partes anterior y posterior de la unidad.

Por su seguridad, nunca corte, quite ni inutilice la conexión eléctrica (tierra) del enchufe. No utilice nunca el anafe con un enchufe adaptador ni un cable prolongador.

ADVERTENCIA: Se puede producir un choque eléctrico por un enchufe conectado a tierra de manera incorrecta. Si tiene alguna duda relacionada con las instrucciones de conexión a tierra, póngase en contacto con un electricista cualificado.

Antes de comenzar:

Asegúrese de que el cable eléctrico está unido firmemente a la unidad CookTek ANTES de conectar la unidad a la electricidad y antes de intentar utilizarla.

- No toque la placa cerámica (situada en la parte superior del anafe) inmediatamente después de utilizarla. El calor de la cazuela se transferirá a la placa cerámica y hará que ésta se caliente.
- La revisión de este producto únicamente puede realizarla un operario de mantenimiento autorizado o el personal de CookTek. No intente abrir la unidad ni realizar ninguna labor de mantenimiento. Para obtener información sobre el mantenimiento, póngase en contacto con CookTek llamando al +1 214-379-6000.
- Este aparato se debe conectar a tierra. Enchúfelo únicamente a una toma conectada a tierra de manera adecuada. Antes de utilizarlo, lea las instrucciones de conexión a tierra y los "Requisitos de la instalación eléctrica" de la página 2 de este folleto. No utilice cables prolongadores.



CookTek Induction Systems, LLC

Phone: 1-800-908-8726
+1 214-379-6000

Fax: +1 214-379-6073

www.cooktek.com

customerservice@turbochef.com
