



Project _____

Item No. _____

Quantity _____

RECTANGULAR SINAQUA™
Drop-in Waterless Buffet Warmer



FEATURES

- Available in 4" or 6" depths with three or six sensors
- Number of sensors determines what pans can be accommodated
 - Three sensors (three temperature zones) can accommodate standard hotel or gastronorm pan or up to three 1/3 pans
 - Six sensors (three temperature zones) can accommodate standard hotel or gastronorm pan, up to three 1/3 pans, or up to six 1/6 pans
- Waterless design – no water or drains needed
- Drop-in design with aluminum housing and a high-impact, easy-to-clean polycarbonate interior surface
- Highly visible and durable capacitive touch user interface
- Automatic pan detection allows for instant energy transmission to pan; almost no energy consumption when pan is not present
- Lock feature prevents unwanted setting changes
- Microprocessor monitors vital components to check for overheating, power supply issues, and more
- Standard Cat 5e or Cat 6 patch cable from unit to controller included
- Available in 100–120 VAC or 200–240 VAC, single phase
- Includes plug and cord (6 ft. nominal)
- One-year limited parts and labor warranty – U.S. and Canada

PERFORMANCE

The CookTek® Drop-in SinAqua™ is a waterless buffet warmer featuring an aluminum housing and a high-impact polycarbonate interior surface. The SinAqua™ requires no water lines or drains and has precise temperature holding for each pan to maximize food quality. Each unit is programmed with an automatic pan detection feature to ensure maximum and efficient warming of induction-compatible pans.*

CERTIFICATIONS

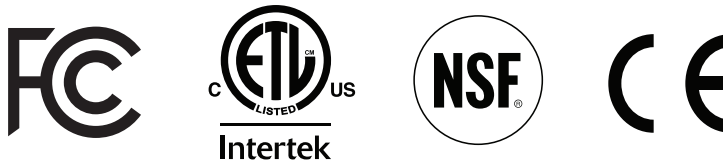

*SinAqua Drop-in Buffet Warmers are designed to be used with induction-compatible pans.

It is the owner and installer's responsibility to comply with all local codes. CookTek reserves the right to make substitutions of components or change specifications without prior notice.

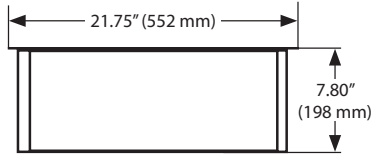

4" Depth Side View

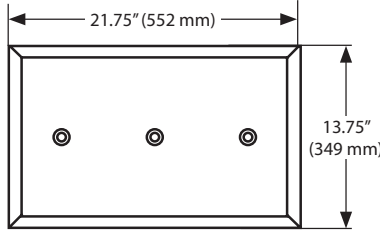

Three (3) Sensor Top View

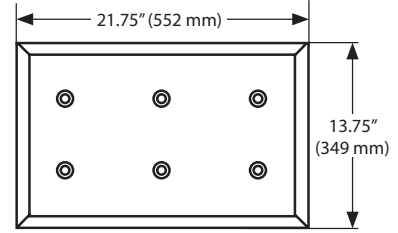

Six (6) Sensor Top View

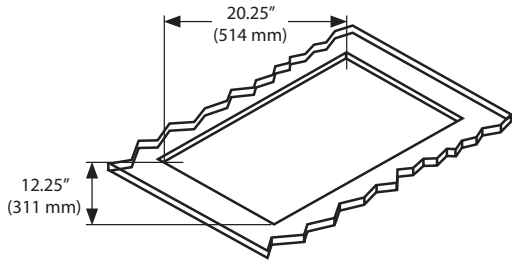

Countertop Cutout Dimensions

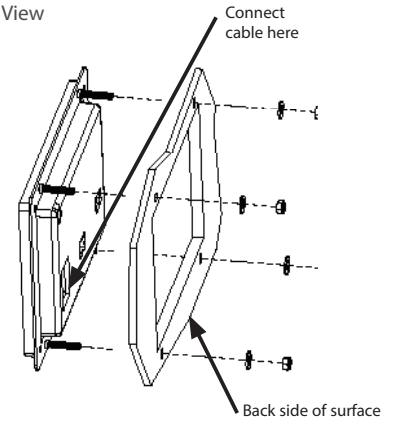
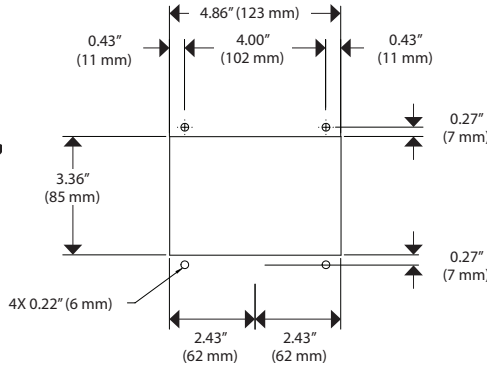

| 4" DEPTH DIMENSIONS | | | |
|--|-----------------|----------------------------|-------------------|
| Full Unit Height | 7.80" | 198 mm | |
| Full Unit Width | 13.75" | 349 mm | |
| Full Unit Depth | 21.75" | 552 mm | |
| Internal (Usable) Height | 4" | 102 mm | |
| Internal (Usable) Width | 12.26" | 312 mm | |
| Internal (Usable) Depth | 20.18" | 513 mm | |
| Cutout Width | 12.25" | 311 mm | |
| Cutout Depth | 20.25" | 514 mm | |
| Weight | 17 lb. | 7.7 kg | |
| CLEARANCE | | | |
| Front | 2" | 51 mm | |
| Sides | 2" | 51 mm | |
| Rear | 2" | 51 mm | |
| Below | 6" | 152 mm | |
| SHIPPING INFORMATION | | | |
| Packaged Height | 12" | 305 mm | |
| Packaged Width | 18" | 457 mm | |
| Packaged Depth | 24" | 610 mm | |
| Packaged Weight | 25.9 lb. | 11.7 kg | |
| Item Class | 250 NMFC #26710 | | |
| ELECTRICAL SPECIFICATIONS (SINGLE PHASE) | | | |
| UNITED STATES/CANADA | | | |
| 3 Sensor (IHW061-34-3) | 685101 | 100-120 V, 50/60 Hz, 650 W | NEMA 5-15P |
| 3 Sensor (IHW062-34-3) | 685201 | 200-240 V, 50/60 Hz, 650 W | NEMA 6-20P |
| 6 Sensor (IHW061-64-3) | 687101 | 100-120 V, 50/60 Hz, 650 W | NEMA 5-15P |
| 6 Sensor (IHW062-64-3) | 687201 | 200-240 V, 50/60 Hz, 650 W | NEMA 6-20P |
| UK/SAUDI ARABIA | | | |
| 3 Sensor (IHW062-34-3) | 685202 | 200-240 V, 50/60 Hz, 650 W | BS1363, 13A, 230V |
| 6 Sensor (IHW062-64-3) | 687202 | 200-240 V, 50/60 Hz, 650 W | BS1363, 13A, 230V |

| INTERNATIONAL | | | |
|------------------------|--------|----------------------------|-----------------------------|
| 3 Sensor (IHW062-34-3) | 685203 | 200-240 V, 50/60 Hz, 650 W | CEE 7/7 Schuko, 16A, 250V |
| 6 Sensor (IHW062-64-3) | 687203 | 200-240 V, 50/60 Hz, 650 W | CEE 7/7 Schuko, 16A, 250V |
| AUSTRALIA | | | |
| 3 Sensor (IHW062-34-3) | 685204 | 200-240 V, 50/60 Hz, 650 W | AS/NZS 3112:2000, 10A, 250V |
| 6 Sensor (IHW062-64-3) | 687204 | 200-240 V, 50/60 Hz, 650 W | AS/NZS 3112:2000, 10A, 250V |
| SOUTH AFRICA | | | |
| 3 Sensor (IHW062-34-3) | 685207 | 200-240 V, 50/60 Hz, 650 W | BS 546, 16A, 250V |
| 6 Sensor (IHW062-64-3) | 687207 | 200-240 V, 50/60 Hz, 650 W | BS 546, 16A, 250V |
| ISRAEL | | | |
| 3 Sensor (IHW062-34-3) | 685208 | 200-240 V, 50/60 Hz, 650 W | SI 32, 16A, 250V |
| 6 Sensor (IHW062-64-3) | 687208 | 200-240 V, 50/60 Hz, 650 W | SI 32, 16A, 250V |

Dedicated circuit required for each installation.

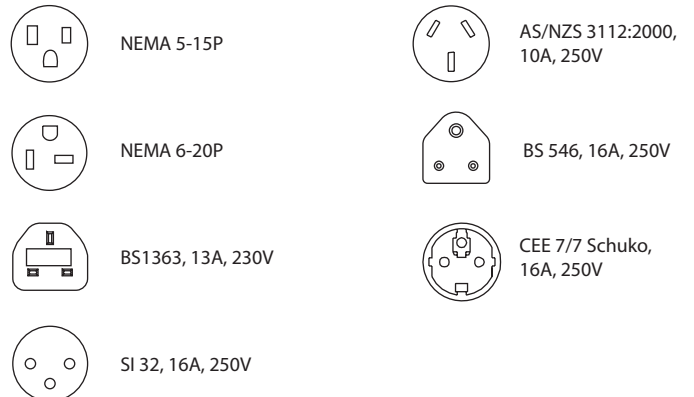

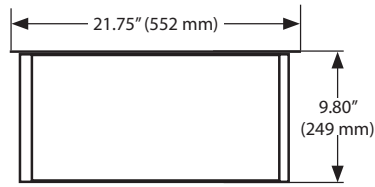

6" Depth Side View

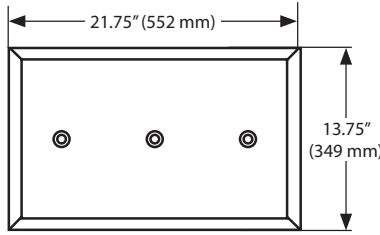

Three (3) Sensor Top View

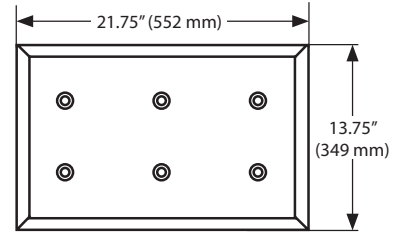

Six (6) Sensor Top View

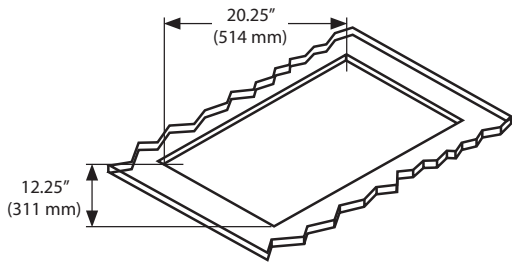

Countertop Cutout Dimensions

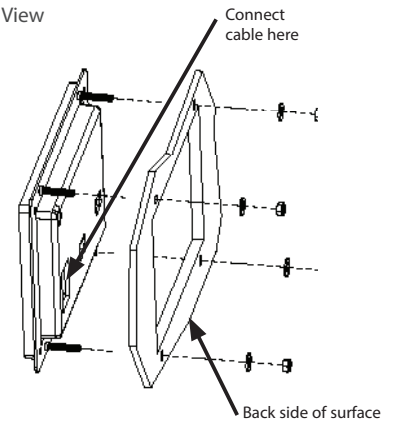
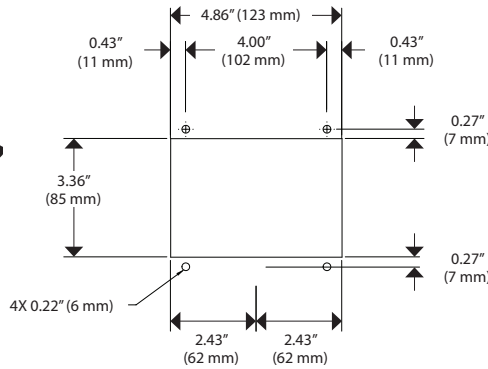

| 6" DEPTH DIMENSIONS | | | |
|--|-----------------|----------------------------|-------------------|
| Full Unit Height | 9.80" | | 249 mm |
| Full Unit Width | 13.75" | | 349 mm |
| Full Unit Depth | 21.75" | | 552 mm |
| Internal (Usable) Height | 6" | | 152 mm |
| Internal (Usable) Width | 12.26" | | 311 mm |
| Internal (Usable) Depth | 20.18" | | 513 mm |
| Cutout Width | 12.25" | | 311 mm |
| Cutout Depth | 20.25" | | 514 mm |
| Weight | 17 lb. | | 7.7 kg |
| CLEARANCE | | | |
| Front | 2" | | 51 mm |
| Sides | 2" | | 51 mm |
| Rear | 2" | | 51 mm |
| Below | 6" | | 152 mm |
| SHIPPING INFORMATION | | | |
| Packaged Height | 12" | | 305 mm |
| Packaged Width | 18" | | 457 mm |
| Packaged Depth | 24" | | 610 mm |
| Packaged Weight | 25.9 lb. | | 11.7 kg |
| Item Class | 250 NMFC #26710 | | |
| ELECTRICAL SPECIFICATIONS (SINGLE PHASE) | | | |
| UNITED STATES/CANADA | | | |
| 3 Sensor (IHW061-36-3) | 684101 | 100-120 V, 50/60 Hz, 650 W | NEMA 5-15P |
| 3 Sensor (IHW062-36-3) | 684201 | 200-240 V, 50/60 Hz, 650 W | NEMA 6-20P |
| 6 Sensor (IHW061-66-3) | 686101 | 100-120 V, 50/60 Hz, 650 W | NEMA 5-15P |
| 6 Sensor (IHW062-66-3) | 686201 | 200-240 V, 50/60 Hz, 650 W | NEMA 6-20P |
| UK/SAUDI ARABIA | | | |
| 3 Sensor (IHW062-36-3) | 684202 | 200-240 V, 50/60 Hz, 650 W | BS1363, 13A, 230V |
| 6 Sensor (IHW062-66-3) | 686202 | 200-240 V, 50/60 Hz, 650 W | BS1363, 13A, 230V |

| INTERNATIONAL | | | |
|------------------------|--------|----------------------------|-----------------------------|
| 3 Sensor (IHW062-36-3) | 684203 | 200-240 V, 50/60 Hz, 650 W | CEE 7/7 Schuko, 16A, 250V |
| 6 Sensor (IHW062-66-3) | 686203 | 200-240 V, 50/60 Hz, 650 W | CEE 7/7 Schuko, 16A, 250V |
| AUSTRALIA | | | |
| 3 Sensor (IHW062-36-3) | 684204 | 200-240 V, 50/60 Hz, 650 W | AS/NZS 3112:2000, 10A, 250V |
| 6 Sensor (IHW062-66-3) | 686204 | 200-240 V, 50/60 Hz, 650 W | AS/NZS 3112:2000, 10A, 250V |
| SOUTH AFRICA | | | |
| 3 Sensor (IHW062-36-3) | 684207 | 200-240 V, 50/60 Hz, 650 W | BS 546, 16A, 250V |
| 6 Sensor (IHW062-66-3) | 686207 | 200-240 V, 50/60 Hz, 650 W | BS 546, 16A, 250V |
| ISRAEL | | | |
| 3 Sensor (IHW062-36-3) | 684208 | 200-240 V, 50/60 Hz, 650 W | SI 32, 16A, 250V |
| 6 Sensor (IHW062-66-3) | 686208 | 200-240 V, 50/60 Hz, 650 W | SI 32, 16A, 250V |

Dedicated circuit required for each installation.



NEMA 5-15P



AS/NZS 3112:2000, 10A, 250V



NEMA 6-20P



BS 546, 16A, 250V



BS1363, 13A, 230V



CEE 7/7 Schuko, 16A, 250V



SI 32, 16A, 250V